

## Uninterruptible power supply - TRIO-UPS-2G/1AC/24DC/5 - 2907160

Rețineți că datele furnizate aici sunt luate din catalogul online. Pentru informații și date complete, consultați documentația de utilizare. În cazul descărcărilor de pe internet se aplică Termenii și condițiile de utilizare generale.  
(<http://download.phoenixcontact.de>)



Uninterruptible power supply with integrated power supply unit. For lead AGM energy storage with 1.3 Ah to 12 Ah nominal capacity. Input: 1-phase, output: 24 V DC/5 A. Push-in connection technology

### Descriere articol

Supply DC loads reliably and save space with the TRIO uninterruptible power supplies. An input grid is no longer necessary for startup. Connected industrial PCs can be shut down easily via the integrated USB interface.

### Caracteristici articol

- Space saving: Combination of UPS module and power supply in the same housing
- Long buffer times, thanks to large selection of VRLA energy storage systems
- USB interface for connection to higher-level controllers such as industrial PCs
- Startup from energy storage possible, even without mains input
- Universal range of possible applications, thanks to a comprehensive package of approvals and an extended temperature range
- Easy installation, thanks to push-in connection technology



### Date comerciale

Unitate de ambalare	1 buc
GTIN	 4 055626 166575
GTIN	4055626166575

### Date tehnice

#### Note

Utilization restriction	EMC: class A product, see manufacturer's declaration in the download area
-------------------------	---

#### Dimensions

Width	60 mm
Height	130 mm
Depth	115 mm
Width with alternative assembly	115 mm
Height with alternative assembly	130 mm

# Uninterruptible power supply - TRIO-UPS-2G/1AC/24DC/5 - 2907160

## Date tehnic

### Dimensions

Depth with alternative assembly	60 mm
Installation distance right/left	0 mm / 0 mm
Installation distance top/bottom	50 mm / 50 mm

### Ambient conditions

Degree of protection	IP20
Inflammability class in acc. with UL 94 (housing / terminal blocks)	V0
Ambient temperature (operation)	-25 °C ... 70 °C (> 60 °C Derating: 2.5 %/K)
Ambient temperature (start-up type tested)	-40 °C
Ambient temperature (storage/transport)	-40 °C ... 85 °C
Max. permissible relative humidity (operation)	≤ 95 % (At +25°C, non-condensing)
Climatic class	3K3 (in acc. with EN 60721)
Degree of pollution	2
Installation height	≤ 4000 m (> 2000 m, observe derating)

### Input data

AC input voltage range	100 V AC ... 240 V AC -15 % ... +10 %
Inrush current limiting/ $I^2t$	< 0.43 A <sup>2</sup> s
Mains buffering time	≥ 15 ms (120 V AC)
Typical response time	60 ms
Input fuse, integrated	6.3 A (slow-blow, internal)

### Output data

Nominal output voltage	24 V DC
Setting range of the output voltage ( $U_{Set}$ )	24 V DC ... 28 V DC (> 24 V constant capacity)
Nominal output current ( $I_N$ )	5 A
Dynamic Boost ( $I_{Dyn.Boost}$ )	7.5 A
Derating	> 60 °C (2.5%/K of $P_{Out,nom.}$ )
Control deviation	< 0.75 % (Static load change 10 % ... 90 %)
Maximum power dissipation in no-load condition	< 3 W (230 V AC)
Efficiency	typ. 85 % (120 V AC)
	typ. 87 % (230 V AC)
	typ. 96 % (Battery operation)
Residual ripple	< 20 mV
Connection in parallel	yes, with diode module uncoupled
Surge protection against internal surge voltages	< 30 V DC
Feedback voltage resistance	≤ 35 V DC

### General

Net weight	0.75 kg
Insulation voltage input/output	3 kV AC (type test)
	1.5 kV AC (routine test)
Protection class	I

# Uninterruptible power supply - TRIO-UPS-2G/1AC/24DC/5 - 2907160

## Date tehnic

### General

MTBF (IEC 61709, SN 29500)	> 1395470 h (230 V AC, at 25 °C)
	> 825726 h (230 V AC, at 40 °C)
	> 388314 h (230 V AC, at 60 °C)
Mounting position	horizontal DIN rail NS 35, EN 60715
Assembly instructions	alignable: horizontally 0 mm, vertically 50 mm

### Connection data, input

Connection method	Push-in connection
Conductor cross section solid min.	0.2 mm <sup>2</sup>
Conductor cross section solid max.	4 mm <sup>2</sup>
Conductor cross section flexible min.	0.2 mm <sup>2</sup>
Conductor cross section flexible max.	2.5 mm <sup>2</sup>
Conductor cross section AWG min.	24
Conductor cross section AWG max.	12
Stripping length	10 mm

### Connection data, output

Connection method	Push-in connection
Conductor cross section solid min.	0.2 mm <sup>2</sup>
Conductor cross section solid max.	4 mm <sup>2</sup>
Conductor cross section flexible min.	0.2 mm <sup>2</sup>
Conductor cross section flexible max.	2.5 mm <sup>2</sup>
Conductor cross section AWG min.	24
Conductor cross section AWG max.	12
Stripping length	10 mm

### Connection data for signaling

Connection method	Push-in connection
Conductor cross section solid min.	0.2 mm <sup>2</sup>
Conductor cross section solid max.	1.5 mm <sup>2</sup>
Conductor cross section flexible min.	0.2 mm <sup>2</sup>
Conductor cross section flexible max.	1.5 mm <sup>2</sup>
Conductor cross section AWG min.	24
Conductor cross section AWG max.	16
Stripping length	8 mm

### Charging process

Charge characteristic curve	I <sub>U</sub> <sub>0</sub> U
Charge current	0.2 A ... 1.5 A (-25 °C ... 60 °C)

### Standards

EMC requirements for noise immunity	EN 61000-6-1
	EN 61000-6-2

# Uninterruptible power supply - TRIO-UPS-2G/1AC/24DC/5 - 2907160

## Date tehnic

### Standards

EMC requirements for noise emission	EN 61000-6-3
	EN 61000-6-4
Standard - safety for equipment for measurement, control, and laboratory use	IEC 61010-1
Standard – Safety extra-low voltage	IEC 61010 (SELV) / (PELV)
Standard - Safe isolation	DIN VDE 0100-410
Standard - power supply devices for low voltage with DC output	EN 61204-3

### Conformance/approvals

UL approvals	UL Listed UL 61010
	UL/C-UL Listed ANSI/ISA-12.12.01 Class I, Division 2, Groups A, B, C

### EMC data

Electromagnetic compatibility	Conformance with EMC Directive 2014/30/EU
Low Voltage Directive	Conformance with Low Voltage Directive 2014/35/EC
Conducted noise emission	EN 61000-6-3 (Class B)
Noise emission	EN 61000-6-3 (Class B)
DNV GL conducted interference	Class B
Additional text	Area power distribution
DNV GL noise radiation	Class B
Additional text	Bridge and deck area
Electrostatic discharge	EN 61000-4-2
Contact discharge	6 kV (Test Level 4)
Discharge in air	8 kV (Test Level 4)
Electromagnetic HF field	EN 61000-4-3
Frequency range	80 MHz ... 6 GHz
Test field strength	10 V/m (Test Level 3)
Comments	Criterion B
Fast transients (burst)	EN 61000-4-4
Input	4 kV (Test Level 4 - asymmetrical)
Output	2 kV (Test Level 3 - asymmetrical)
Signal	1 kV (Test Level 4 - asymmetrical)
Comments	Criterion B
Input	2 kV (Test Level 3 - symmetrical)
	4 kV (Test Level 4 - asymmetrical)
Output	1 kV (Test Level 1 - symmetrical)
	2 kV (Test Level 3 - asymmetrical)
Signal	1 kV (Test Level 2 - asymmetrical)
Comments	Criterion B
Conducted interference	EN 61000-4-6
I/O/S	asymmetrical
Frequency range	0.15 MHz ... 80 MHz

# Uninterruptible power supply - TRIO-UPS-2G/1AC/24DC/5 - 2907160

Date tehnice

EMC data

Voltage	10 V (Test Level 3)
Comments	Criterion A
Attenuated sinusoidal oscillations (ring wave)	EN 61000-4-12
Input	2 kV (symmetrical)
	4 kV (asymmetrical)
Comments	Criterion B
Criterion A	Normal operating behavior within the specified limits.
Criterion B	Temporary impairment to operational behavior that is corrected by the device itself.

Environmental Product Compliance

REACH SVHC	Lead 7439-92-1
------------	----------------

Desene

Block diagram

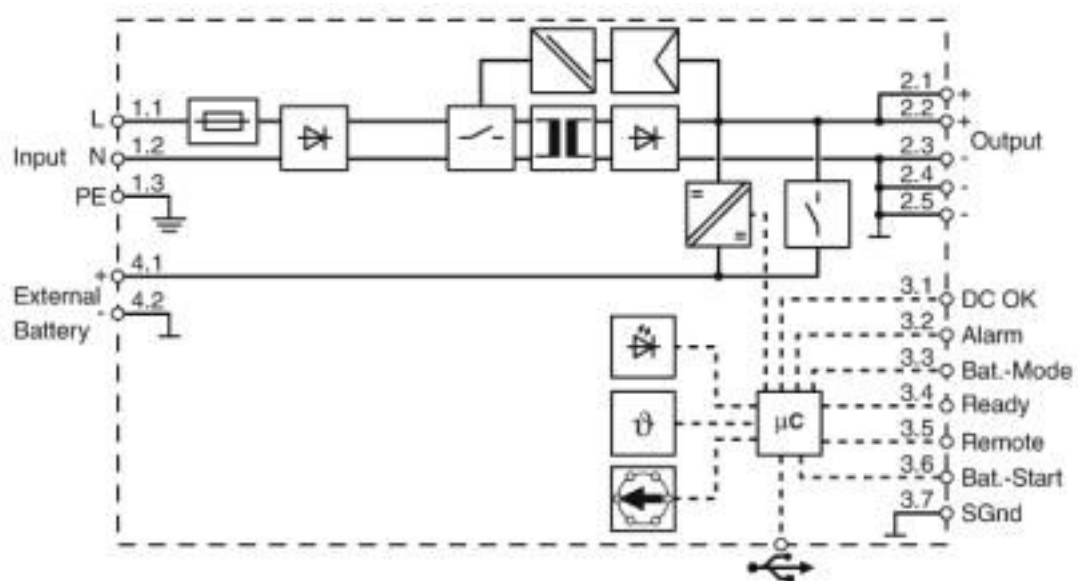

Aprobări

Aprobări

Aprobări

DNV GL / BSH / UL Listed / cUL Listed / EAC / IECCE CB Scheme / LR / cULus Listed







Aprobări EX

UL Listed / cUL Listed / cULus Listed

# Uninterruptible power supply - TRIO-UPS-2G/1AC/24DC/5 - 2907160

## Aprobări

### Detalii de aprobare

DNV GL		<a href="https://approvalfinder.dnvgl.com/">https://approvalfinder.dnvgl.com/</a>	TAA00002DW
BSH			1025a
UL Listed		<a href="http://database.ul.com/cgi-bin/XYV/template/LISEXT/1FRAME/index.htm">http://database.ul.com/cgi-bin/XYV/template/LISEXT/1FRAME/index.htm</a>	FILE E 123528
cUL Listed		<a href="http://database.ul.com/cgi-bin/XYV/template/LISEXT/1FRAME/index.htm">http://database.ul.com/cgi-bin/XYV/template/LISEXT/1FRAME/index.htm</a>	FILE E 123528
EAC			RU*DE*08.B.01873/19
IECEE CB Scheme		<a href="http://www.iecee.org/">http://www.iecee.org/</a>	DK-63811-UL
LR		<a href="http://www.lr.org/en">http://www.lr.org/en</a>	LR2002877TA
cULus Listed			

### Accesorii

#### Accesorii

#### Assembly adapter

#### Assembly adapters - UWA 130 - 2901664



2-piece universal wall adapter for securely mounting the device in the event of strong vibrations. The profiles that are screwed onto the side of the device are screwed directly onto the mounting surface. The universal wall adapter is attached on the left/right.

# Uninterruptible power supply - TRIO-UPS-2G/1AC/24DC/5 - 2907160

## Accesorii

---

### Battery unit

Energy storage - UPS-BAT/VRLA/24DC/1.3AH - 2320296



Energy storage device, lead AGM, VRLA technology, 24 V DC, 1.3 Ah, tool-free battery replacement, automatic detection, and communication with QUINT UPS-IQ

---

Energy storage - UPS-BAT/VRLA/24DC/3.4AH - 2320306



Energy storage device, lead AGM, VRLA technology, 24 V DC, 3.4 Ah, tool-free battery replacement, automatic detection, and communication with QUINT UPS-IQ

---

Energy storage - UPS-BAT/VRLA/24DC/7.2AH - 2320319



Energy storage device, lead AGM, VRLA technology, 24 V DC, 7.2 Ah, tool-free battery replacement, automatic detection, and communication with QUINT UPS-IQ

---

Energy storage - UPS-BAT/VRLA/24DC/12AH - 2320322



Energy storage device, lead AGM, VRLA technology, 24 V DC, 12 Ah, tool-free battery replacement, automatic detection, and communication with QUINT UPS-IQ

---

### Data cable preassembled

Data cable - MINI-SCREW-USB-DATACABLE - 2908217



Used for communication between an industrial PC and Phoenix Contact devices with USB-Mini-B connection.

---

Phoenix Contact 2020 © - all rights reserved  
<http://www.phoenixcontact.com>

PHOENIX CONTACT ROMANIA  
Splaiul Unirii 165 Timpuri Noi Square TNO1, Etaj 1  
Bucuresti 030133  
Romania  
+40 21 350 88 12 - 3  
+40 37 448 56 32 - 7  
<http://www.phoenixcontact.ro>